



APPLICATION GUIDE

FRONIUS GEN24, Verto, Tauro, SnapINverter Multi-Inverter Export Limit Setup

Fronius reserves all rights, in particular rights of reproduction, distribution and translation.

No part of this work may be reproduced in any way without the written consent of Fronius. It must not be saved, edited, reproduced or distributed using any electrical or electronic system. You are hereby reminded that the information published in this document, despite exercising the greatest of care in its preparation, is subject to change and that neither the author nor Fronius can accept any legal liability

Gender-specific wording refers equally to female and male form.

CHANGE LOG

DATE	VERSION	COMMENTS	AUTHOR
16/09/2024	1.0	First version	Fronius Australia

SCOPE

This document describes the process how to setup and commission multi-inverter sites for Export Limitation where either a GEN24, Tauro or Verto inverter series are part of the system.

Where the system is made up of ONLY SnapINverters, please consult our other Application Guides on daisy chaining SnapINverters via SolarNet loop.

The following inverter series are relevant to this document:

- **Fronius Primo & Symo GEN24 and GEN24 Plus**
- **Fronius Verto**
- **Fronius Tauro & Tauro ECO**
- **Fronius SnapINverter Primo, Symo, ECO, Galvo**

GENERAL

The following Export Limiting function for multi-inverter systems is valid for **up to 20 Fronius Inverters** on one site. This multi-inverter Export Limiting function differs from the pure SnapINverter / SolarNet configuration in that it utilizes a star type TCP/IP topology rather than an RS422 series daisy chaining topology. The router is the central connection point and forms the hub of the control system. The master inverter communicates to the Slave inverters via the router. It is therefore essential that the network connection quality between each inverter and the router is strong and reliable.

At present the described function herein is purely for Export Limiting of multiple inverters.

Therefore, this feature does **not** provide any of the following functions:

- Forwarding of external Modbus commands from the Master inverter to the Slave inverters
- Controlling of multiple hybrid inverters with batteries connected to each inverter.
- Parallel Backup Power operation with several hybrid inverters in a system

1 Components

The following components are **required** as part of the system:

Fronius inverters as MASTER or SLAVE:

- Fronius Primo or Symo GEN24, GEN24 Plus
- Fronius Verto
- Fronius Tauro or Tauro ECO

NOTE: The **MASTER** inverter that controls the remaining devices in the network **must** be a Fronius GEN24, GEN24 Plus, Verto or Tauro and **cannot** be a Fronius SnapINverter.

A minimum inverter firmware version of $\geq 1.32.x-x$ is requirement for the MASTER inverter (GEN24, GEN24 Plus or Tauro)

Fronius inverters as SLAVE only (optional):

- Fronius Primo, Symo, Eco SnapINverters

All Fronius Primo, Symo and Symo Advanced SnapINverters support the Multi-Inverter Export Limiting function as SLAVE inverters. At least one SnapINverter with Datamanager is required. Further information can be found under Configuration.

Supported Fronius Smart Meters:

- Smart Meter 63A-1; 63A-3; 50kA-3
- Smart Meter WR, 480V UL; 240V UL
- Smart Meter IP

Router:

A router is required so that all inverters can communicate with each other. Ensuring that all inverters are connected to the same network is essential.

NOTE: A hard wired ethernet connection to the inverters is recommended to ensure stable and reliable operation. Where a Wi-Fi connection is the only possible connection, the signal strength must be equal or better than 

- Click on “Communication” then “Network” to check the signal strength.

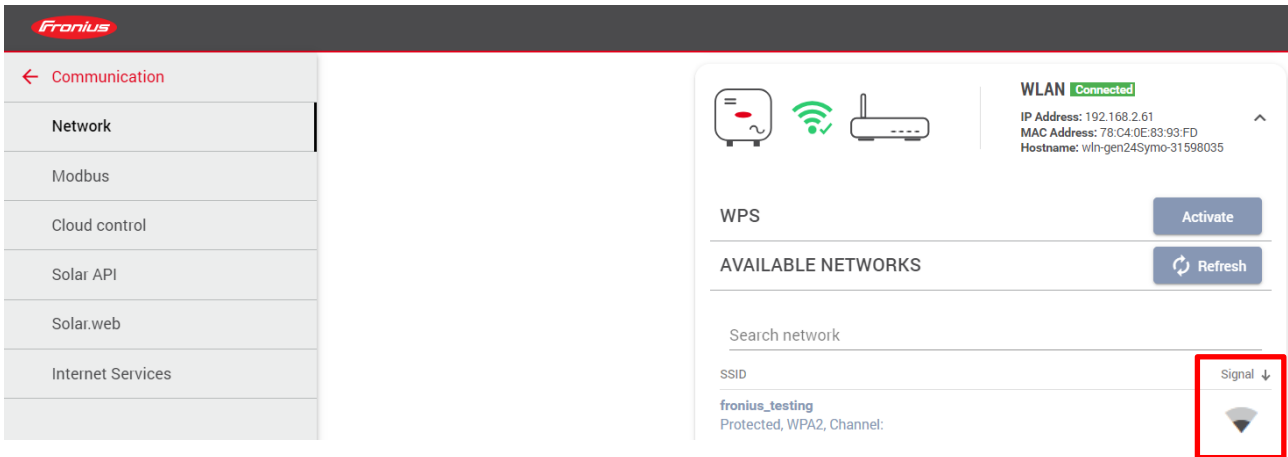

2 General Configuration

Network configuration:

All components / devices **must** be connected to the same network & subnet to ensure communication.

Smart Meter connection:

The Smart Meter must be connected to the **MASTER** inverter, on which the configuration settings will be made. This **MASTER** inverter must be either a GEN24 [Plus], Tauro or Verto inverter.

Maximum number of inverters:

The system can support a maximum of 20 inverters (1 Master + 19 Slaves).

Exceeding this limit can impair data transmission and whole system functionality.

SnapINverter daisy chain / SolarNet:

A maximum of **five** SnapINverters connected via **Solar.net ring** is supported. The first SnapINverter in the daisy chain must have a Datamanager, while the remaining four SnapINverters can be “light” devices without a Datamanager. Several SnapINverter chains can also be operated in parallel.

Data transmission and communication:

Data communication between the inverters is realised via Modbus TCP, which ensures efficient and reliable transmission.

Control of the inverter via Modbus TCP must be activated for each inverter (except for the master inverter and the SnapINverter “Light”). The specific steps for activation are described in Chapter 3.

Battery storage:

One battery system setup connected to the **GEN24 Plus master** is supported.

Several stacks connected to the GEN24 Plus master are possible in accordance with the manufacturer’s specifications.

Example system configuration:

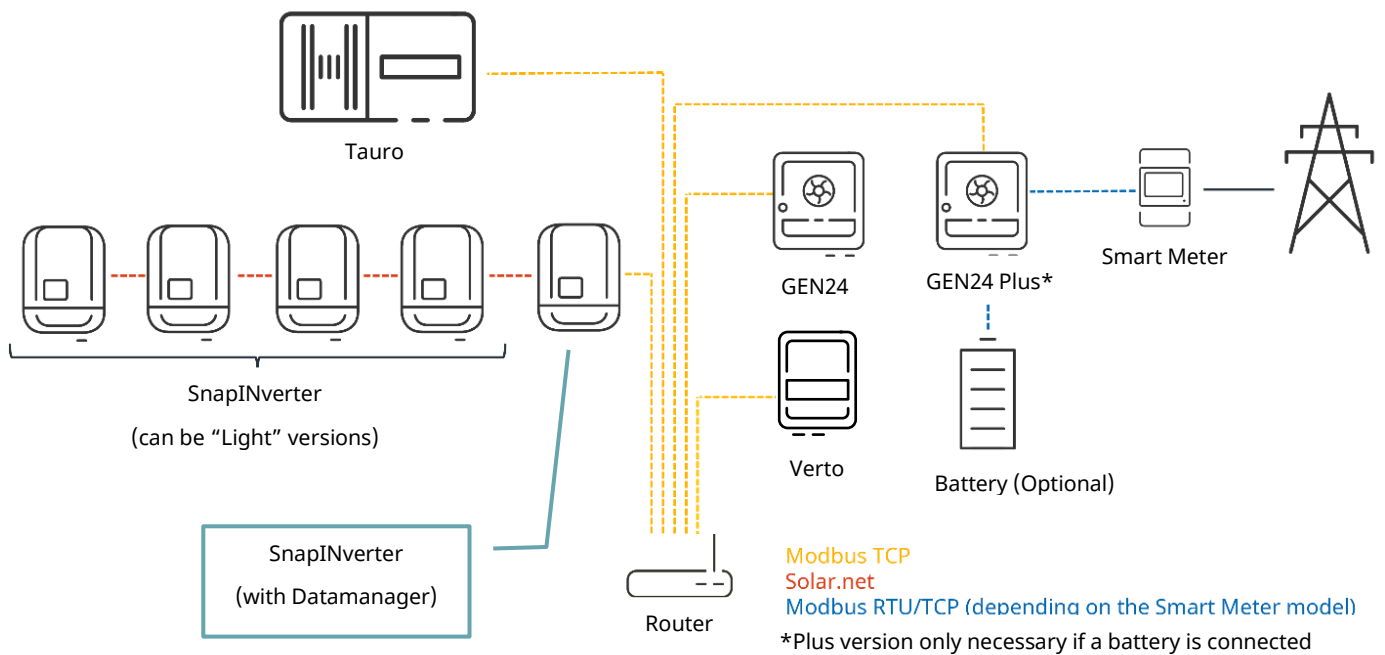

3 Inverter Configuration Setup

3.1 “MASTER” Inverter Setup (GEN24/Tauro/Verto):

NOTE: Before configuring the “Master” inverter, all inverters in the system (including all “Slave” inverters) **must** be commissioned with the Solar.start app or via the Web user interface.

Connect to the user web interface and login using the **“Technician”** password.

If required, see our YouTube video: *How-To video: Connecting to the user interface of the GEN24/Tauro*

- Click on **“Safety and grid requirements”** in the menu on the left and then select **“Export limitation”**.

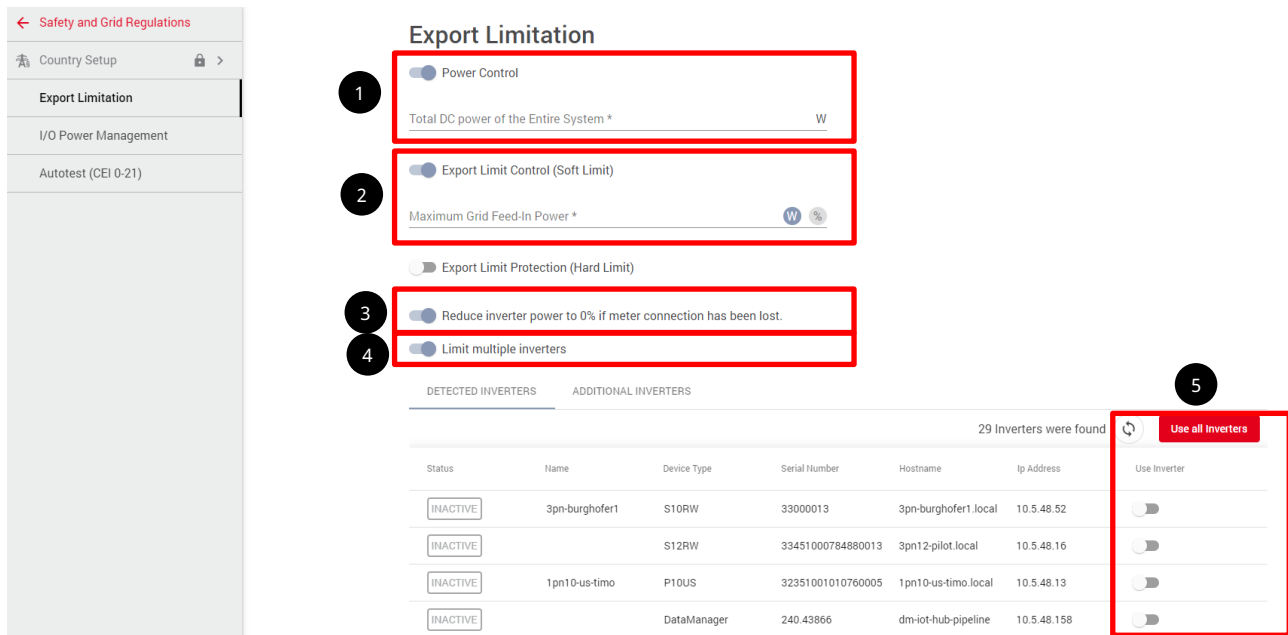

1. Activate **“Power limitation”** and enter the total system power (DC) in watts.
2. Activate **“Export Limit Control (Soft limit)”** and enter the max. site grid feed-in power in W.
3. Ensure that **“Reduce inverter power to 0% if meter connection has been lost”** is activated.
4. Activate **“Limit multiple inverters”**
5. Under **“Use Inverter”** select the inverters to be export limited. Click on **“Save”**.

Status description of the “Slave” inverters:

Inactive	Power Control for the “Slave” inverter is not configured.
Disconnected	Power Control for the “Slave” inverter is configured but does not respond via Ethernet/WLAN.
Connected	Power Control for the “Slave” inverter is configured and is available and controllable via Ethernet/WLAN.

3.2 “SLAVE” inverter Setup (GEN24, Tauro, Verto or SnapINverter):

There are 4 x functions must be configured on ALL **SLAVE** inverters:

- **Activate Modbus as Slave**
- **Setup fallback / failsafe function and value**
- **Set Controlling Priorities**
- **Deactivate Ramp UP Communication**

3.2.1 GEN24/Tauro/Verto inverters

Connect to the user web interface and login as “**Technician**”

If required, see our YouTube video: *How-To video: Connecting to the user interface of the GEN24/Tauro*

3.2.1.1 Activate Modbus as Slave:

- Click on “**Communication**” in the menu on the left.

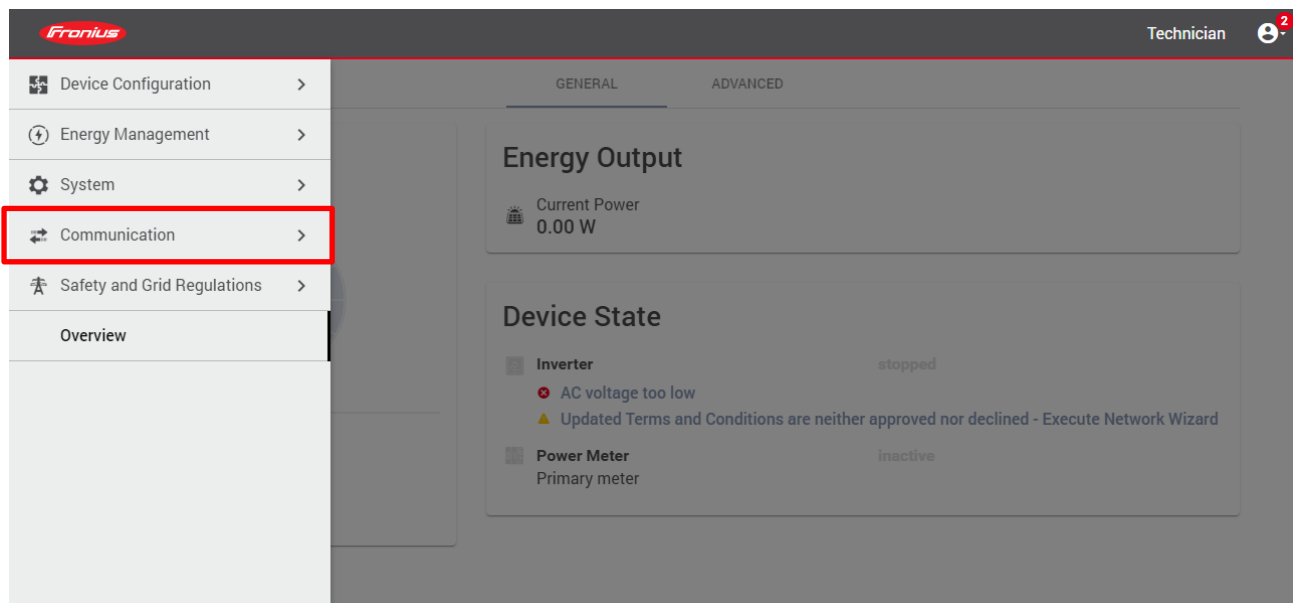

- Then click on **“Modbus”**.

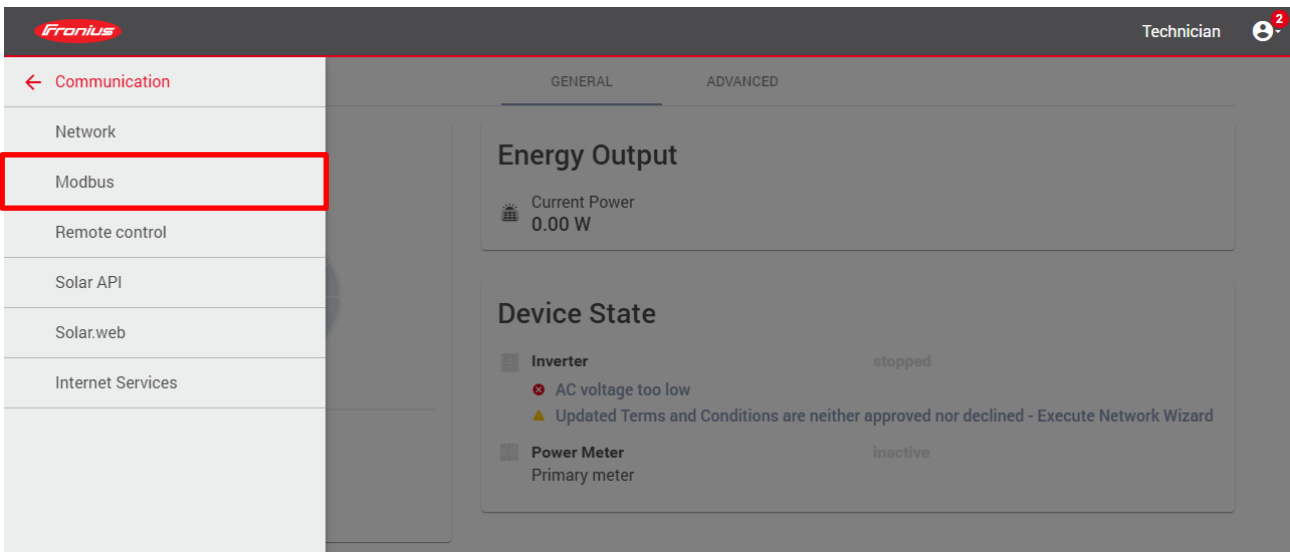

- Activate **“Slave as Modbus TCP”**.
- Activate **“Inverter control via Modbus”**.
- Click on **“Save”**.

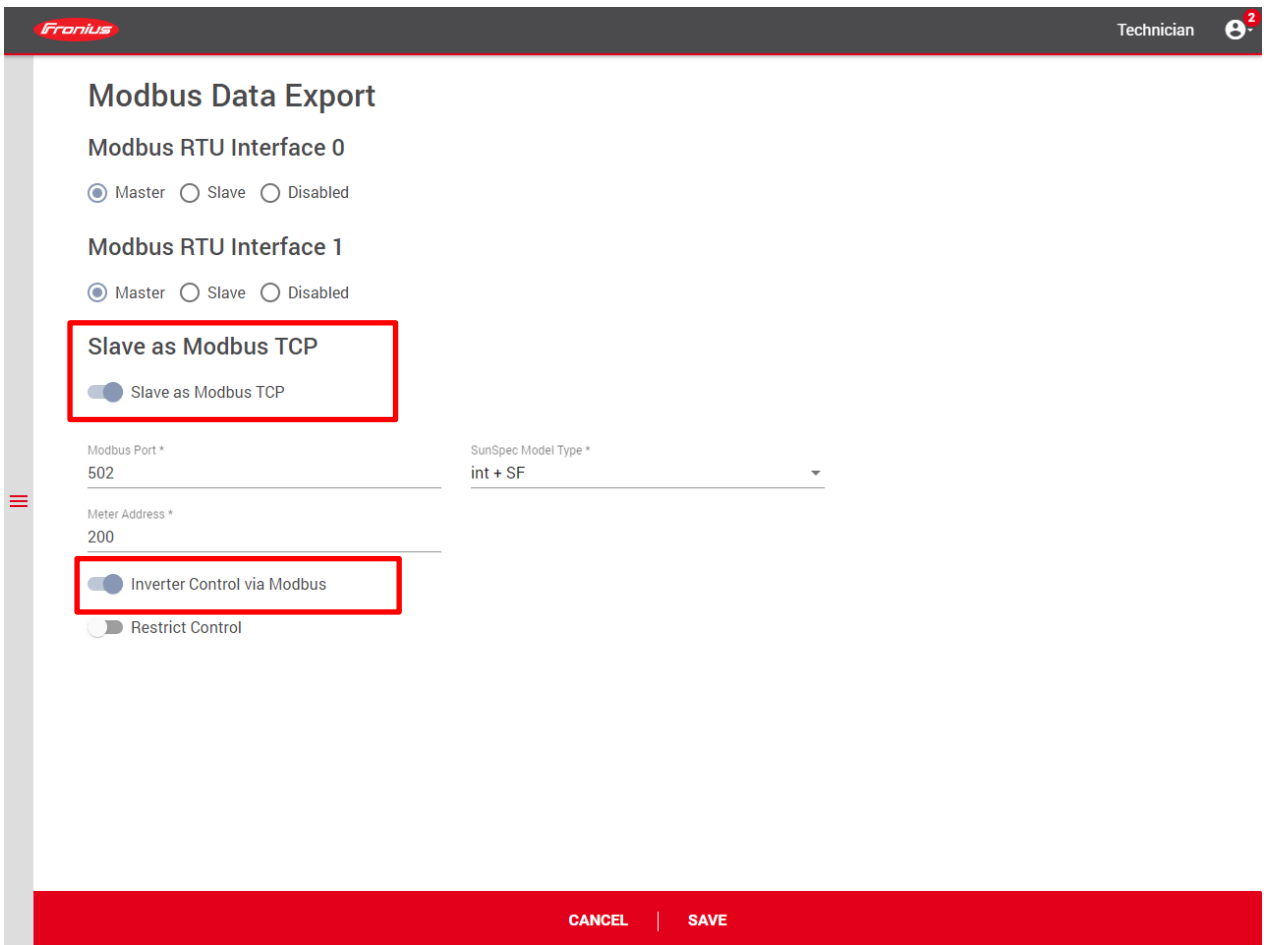

3.2.1.2 Setup fallback / failsafe function and value:

NOTE: The value set in the “**Export Limit Control (Soft limit)**” section on all **SLAVE** inverters **is not** the export limit that the inverter will use in normal operation. This is purely the fallback/failsafe value to which the inverter will fall back to when comms are lost to the **MASTER** Inverter.

- Click on “**Safety and grid regulations**” in the menu on the left and then select “**Export limitation**”.

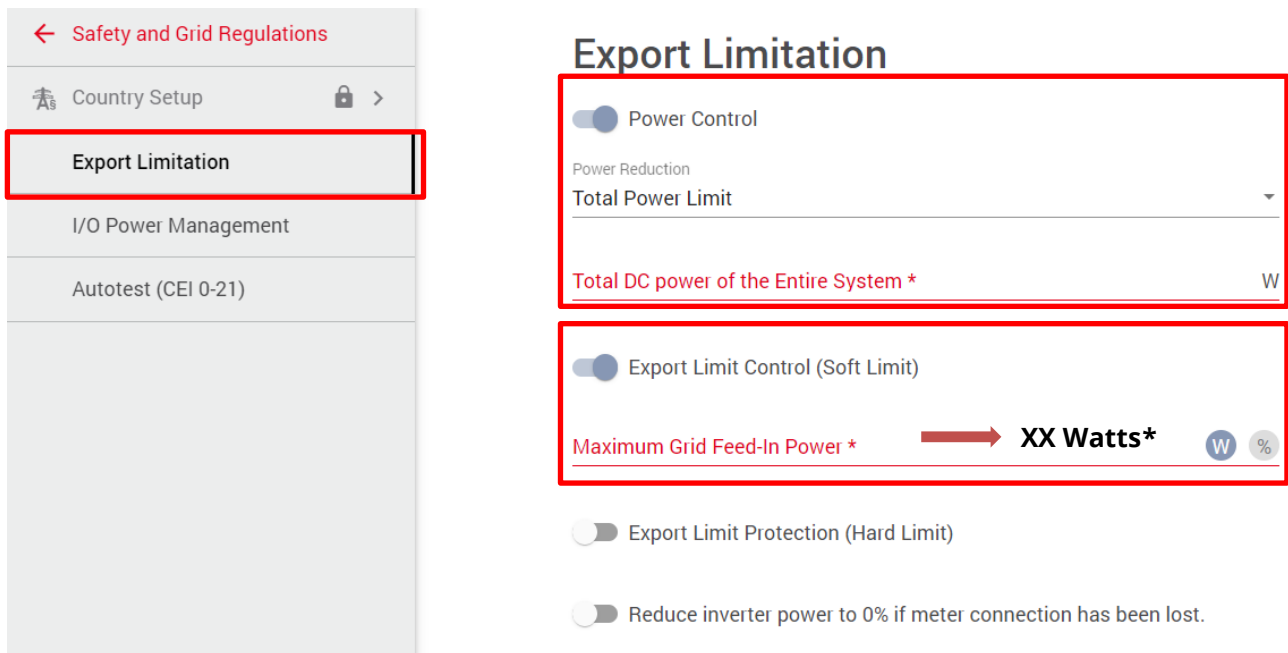

- Activate “**Power Control**” and add the Total DC power of the Entire System.
- Activate “**Export Limit Control (Soft limit)**” and set the fallback value*
- Click on “**Save**”.

*The fallback value can be set to a site-specific target or 0W

e.g. A system with 3 x Symo GEN24 10.0 inverters (30kW in total) with a total site export limit of 10kW.

In this case the “**Export Limit Control (soft limit)**” can be set to 5000W per **Slave** inverter.

MASTER inverter will go to 0W due to the “**Reduce inverter power to 0% if meter connection has been lost**” setting (see 3.1).

SLAVE inverters combined will produce 10,000W in fallback mode.

3.2.1.3 Set Controlling priorities:

- Click on **"I/O Power Management"**
- Set **"Controlling Priorities"** to:
 1. IO Powerlimit
 2. Modbus Control
 3. Export Limitation
- Click on **"Save"**

The screenshot shows the Fronius I/O Power Management configuration page. On the left, a sidebar menu has 'I/O Power Management' highlighted with a red box. The main content area is titled 'I/O Power Management' and includes a pin configuration table, a 'DNO feedback pin' dropdown, a 'Rules' section with four rules, and 'Import' and 'Export' buttons. Below this, a 'Controlling Priorities' section is highlighted with a red box, containing a list with three items: '1. IO Powerlimit', '2. Modbus Control', and '3. Export Limitation'. On the right side of the page, there is a vertical list of pin numbers 0 through 11, each with 'None' next to it.

V+/GND	IO	I				
V+	0	2	4	6	8	10
V-	1	3	5	7	9	11
GND						

DNO feedback pin
Pin 0

Rules

- Rule 1
- Rule 2
- Rule 3
- Rule 4

Import Export

Controlling Priorities

1. IO Powerlimit
2. Modbus Control
3. Export Limitation

0	None
1	None
2	None
3	None
4	None
5	None
6	None
7	None
8	None
9	None
10	None
11	None

3.2.1.4 Deactivate Ramp UP Communication function:

In order to allow the inverter to ramp without delay or gradient the **Ramp-Up Communication** needs to be disabled.

- Click on **“Country Setup”**

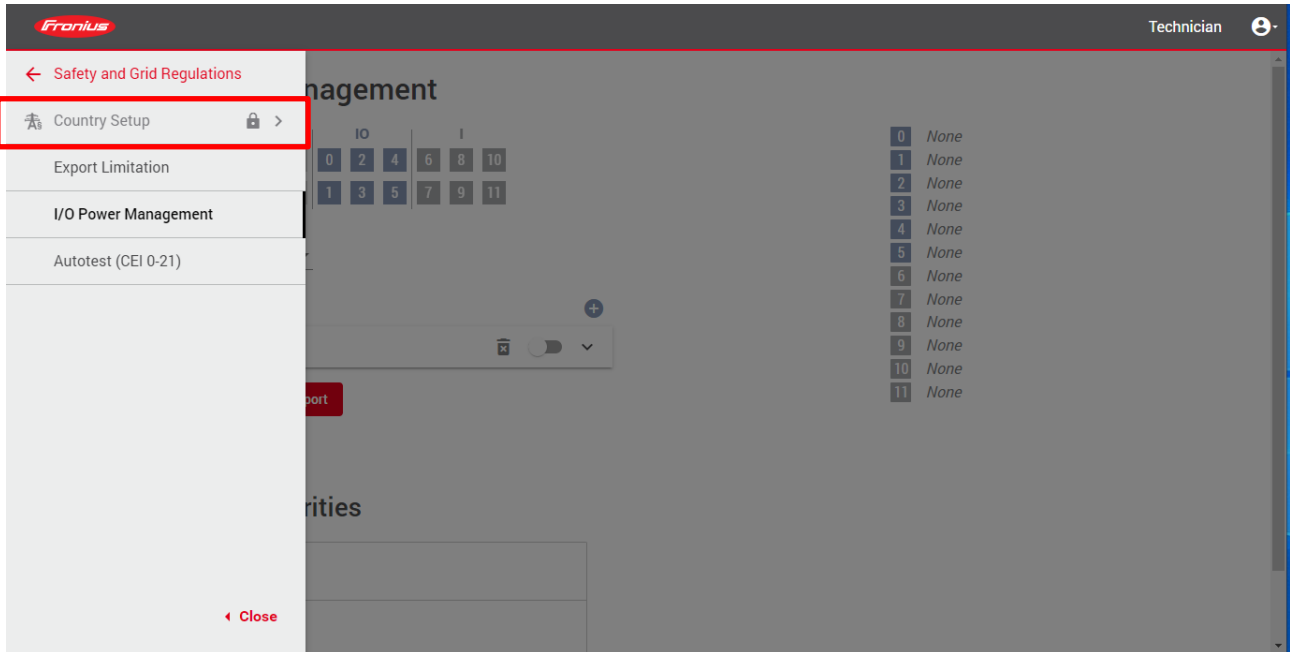

- Enter Access Code Country Setup **“77634”**
- Click on **“Unlock”**

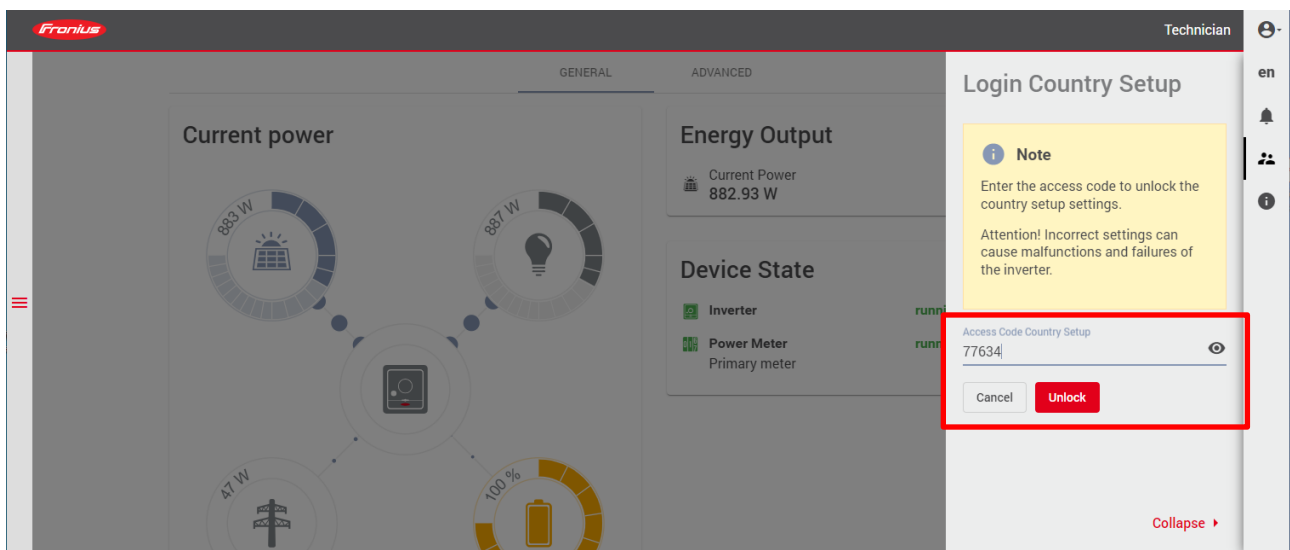

- Click on **“General”**
- Scroll down to **“Ramp-Up Communication”**
- Set **“Ramp-Up Communication”** to **“Off”**
- Click on **“SAVE”**

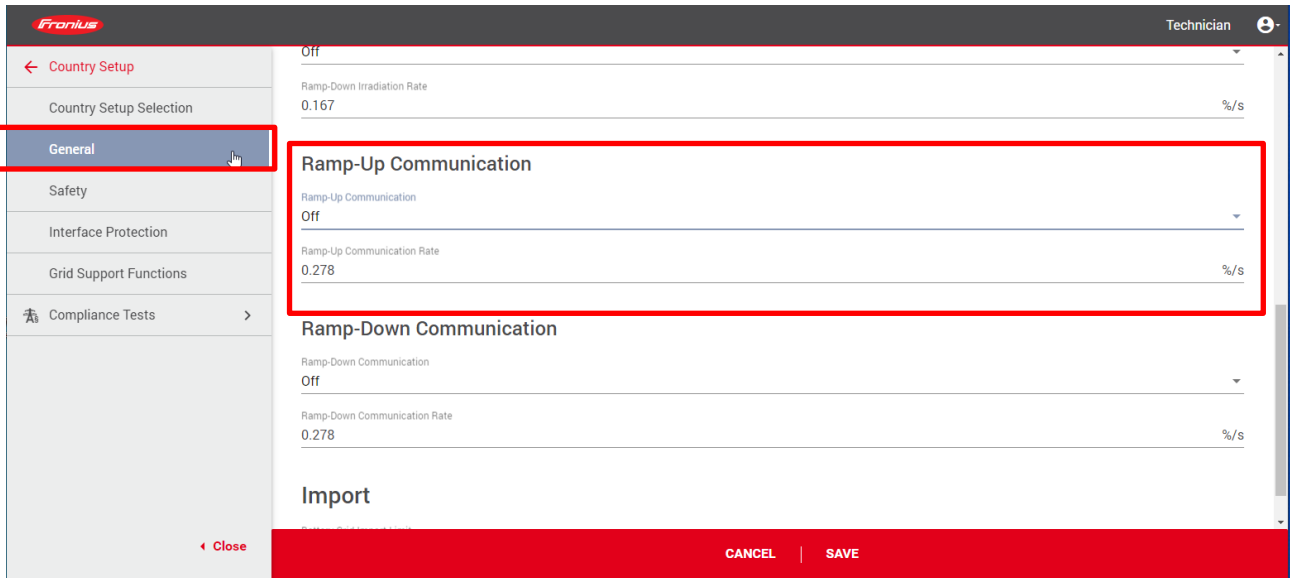

3.2.2 SnapINverter (Datamanager)

Connect to the user web interface and login as **“Service”**

If required, see our YouTube video: *How-To video: Connecting to the user interface of the Datamanager*

3.2.2.1 **Activate Modbus as Slave:**

1. Click on **“Settings”**.
2. Select **“Modbus”**.
3. Set the point at **“tcp”**.
4. Activate **“Inverter control via Modbus”**.
5. Click on the **“Tick”** to save the settings.

- Set **“Limit entire system”** in the **“Dynamic power reduction”**
- Set **“Total DC system power of the system”** and **“Maximum grid feed-in power”** to **“X Watts”***
- Click on the **“check”** to save the settings.

✓ ✕

Dynamic power reduction

Export Limitation No Limit **Limit Entire System** Limit per Phase (not for single-phase devices)

total DC power of the system

Export Limit Protection (Hard Limit Trip)

Export Limiting Control (Soft Limit)
 Maximum Grid Feed-In Power **→ X Watts***

Reduce inverter power to 0% if meter connection has been lost.

*The fallback value can be set to a site-specific target or 0W

e.g. A system with 2 x Symo GEN24 10.0 inverters and 1 x Symo SnapINverter (30kW in total) with a total site export limit of 10kW. In this case the **“Export Limit Control (soft limit)”** can be set to 5000W per **SLAVE** inverter. **MASTER** inverter will go to 0W due to the **“Reduce inverter power to 0% if meter connection has been lost”** setting (see 3.1).

SLAVE inverters combined will produce 10,000W in fallback mode.

3.2.2.3 **Set Controlling Priorities:**

- Set **“Controlling Priorities”** to:
 1. IO Powerlimit
 2. Modbus Control
 3. Export Limitation
- Click on the **“Tick”** to save the settings.

✓ ✕

Controlling priorities

<input type="button" value="▼"/> <input type="button" value="▲"/> <input type="button" value="▼"/> <input type="button" value="▲"/>	<p>1. IO control</p> <p>2. Controlling via Modbus</p> <p>3. Dynamic power reduction</p>	<p>Legend:</p> <p>1 ... highest priority</p> <p>2 ... medium priority</p> <p>3 ... lowest priority</p>
---	---	---

3.2.2.4 Deactivate Power Gradient Ramp UP function:

On the inverter's LCD (Display) the **Power Change Gradient UpRamp** is required to be turned **OFF** so that the inverter ramps up its power with no delay of gradient.

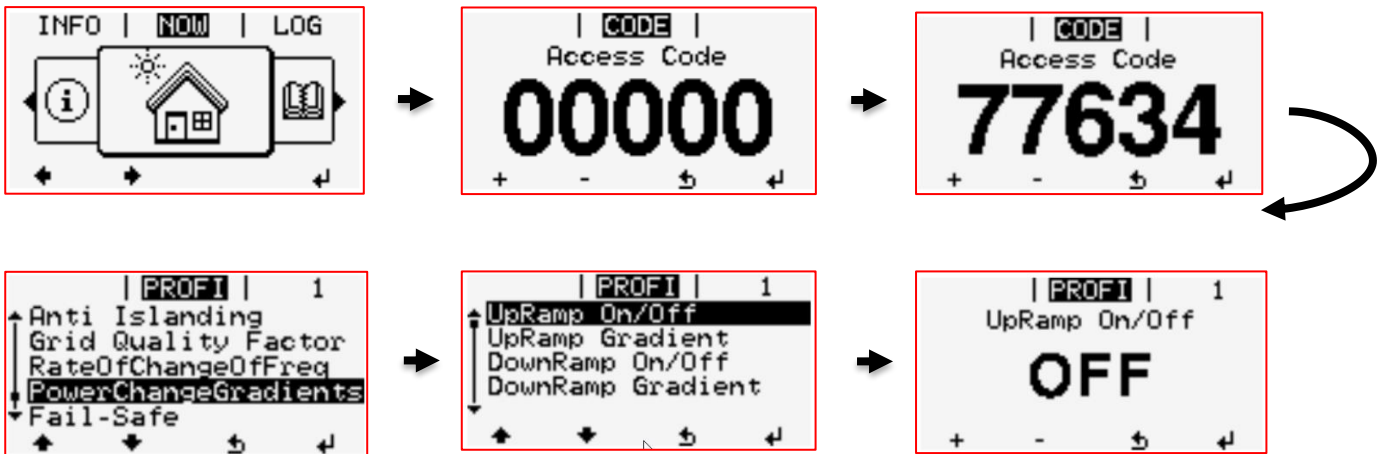

4 Solar.web Setup

To achieve a complete site overview, the individual data sources of the inverters can be added to the same Solar.web system. This can be done either directly when creating the PV system or subsequently under **“Settings”** and then **“Components”** then **“Add Device”**

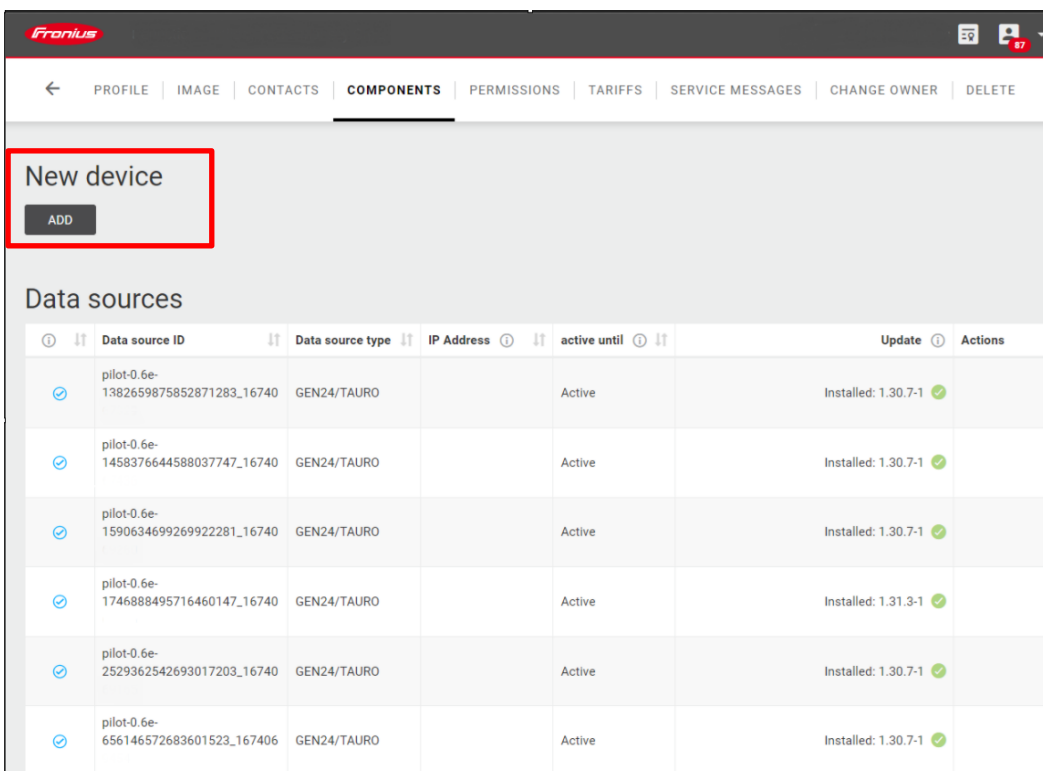

END OF DOCUMENT

Fronius Australia Technical Support

Email: PV-Support-Australia@fronius.com

Phone: 03 8340 2910

For more detailed information see the operation manual available on the product specific page on [here](#).